

USER MANUAL

Digital Mixer

SOUNDKING AUDIO
WWW.SOUNDKING.COM

All rights reserved to SOUNDKING.

No part of this manual may be reproduced, translated or photocopied
by any means for any purpose, without the written permission of SOUNDKING.

The information involved in this manual is subject to change without notice.
Never disassemble the unit by yourself, it may cause the invalidation of warranty.

ECNJG2204110

INDEX

Intro.....	2
Featur.....	2
Control and connection.....	3
Input channel.....	7
MIC channel.....	7
Input Stage subpage.....	8
EQ subpage.....	9
Dynamics subpage.....	10
Bus Send subpage.....	12
Output Stage subpage.....	13
Stereo channel.....	14
Input Stage subpage.....	14
EQ subpage.....	15
Dynamics subpage.....	15
Bus Send subpage.....	16
Output Stage subpage.....	16
Output BUS.....	16
BUS.....	17
Input Stage subpage.....	17
EQ subpage.....	19
Output Stage subpage.....	19
Setup page.....	20
Patch page.....	22
Meter page.....	23
FX pag.....	23
Modulation subpage.....	24
Delay subpage.....	25
Reverb subpage.....	27
GEQ subpage.....	29
Scenes page.....	30
Recorder page.....	31
Monitor page.....	32
Wife page.....	33
Signal Flow Chart.....	37
Specification.....	38

Specification

Model	DM20	DB20P	DB20P-600	DB20P-1000
Line input	12 MIC(4 COMBO), 2 Stereo, S/PDIF input, USB input			
Input channel function	Phase, Delay, high pass filter, 4-band parametric EQ, noise gate, Compressor, L/R Pan, Effects			
Line output	8 assignable XLR + AES/EBU, S/PDIF and stereo headphone			
Internal signal generator	white noise/ sine wave/ pink noise			
Phantom power	48V, each channel switchable alone			
USB function	USB playback/recording(WAV), system upgrade, scene storage, external USB network card			
Screen	7" 1024x600 IPS high definition touch screen			
AD/DA	max support 192KHz/24-bit			
Sample frequency	48kHz			
DSP	fourth generation ADI 40-bit float point SHARC processor, 450M			
Effects	up to 8 effect modules(2 Reverb, 2 Modulation, 2 Delay and 2 15-band GEQ)			
System	custom Android system			
Network	yes via external USB module			
IPAD control	Yes			
Internal AMP output	No	No	4*150W 4 Ω	2*500W 4 Ω
Power supply	100-240V 50/60Hz	100-240V 50/60Hz	100 - 120V 50/60Hz 200 - 240V 50/60Hz	100 - 120V 50/60Hz 200 - 240V 50/60Hz
Dimension	429*335*83mm	127*483*177mm	193*483*177mm	193*483*177mm
Weight	3.2kg	4.3kg	6kg	6kg

Signal Flow Chart

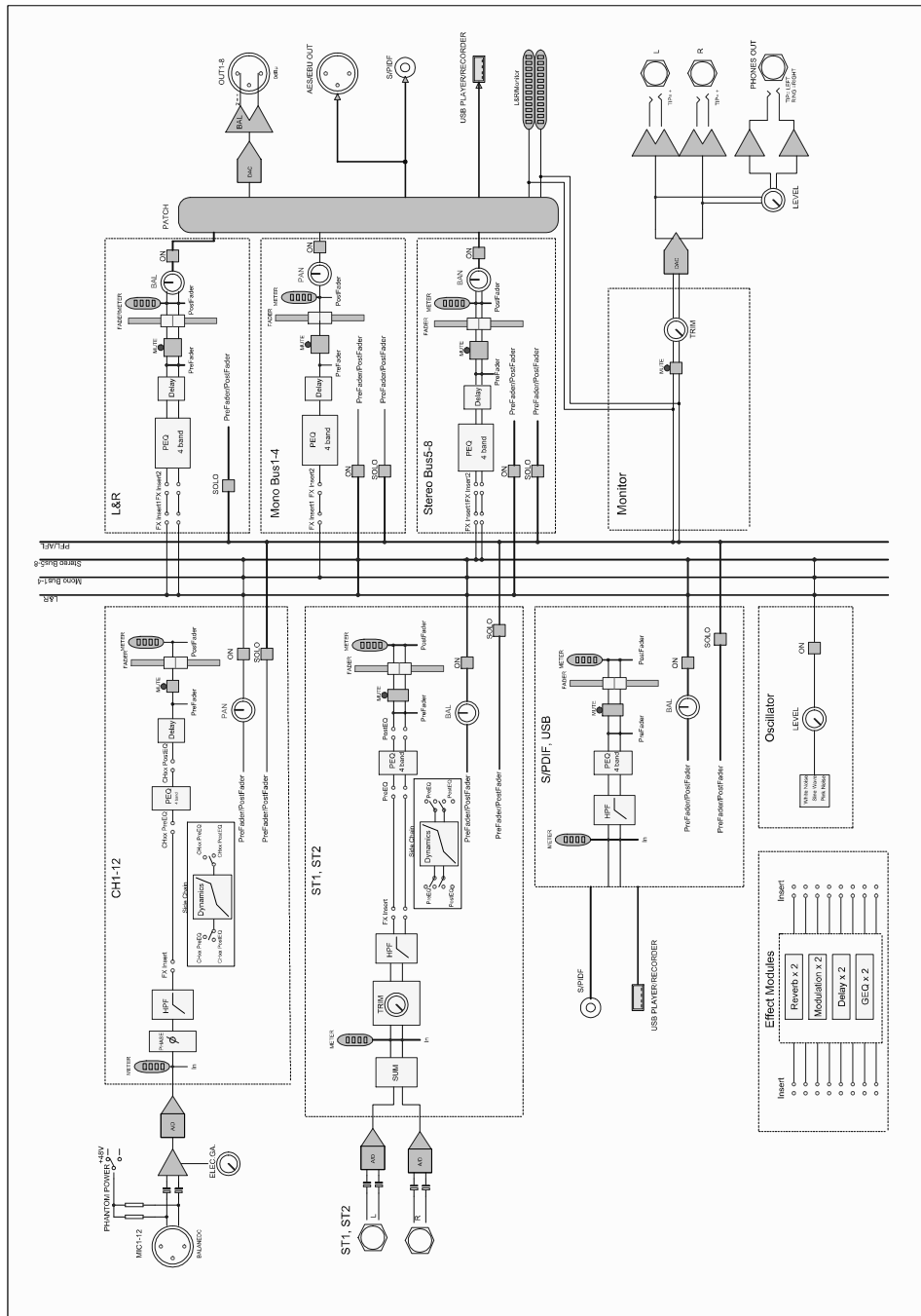

Intro.

This is a full function compact digital mixer from Soundking that features premium hardware, touch operation, iPad remote control, the 4th generation SHARC floating point processor, 24bit/192kHz AD/DA conversion, 8 effect modules, reverb, delay, modulation, GEQ, 20 inputs including 12 pro mic and 2 stereo, professional digital signal input port, 16 BUSSES including 8 assignable analog and digital output ports. It has two USB interfaces for recording, playback, scene memory, WIFI connection. Furthermore, it is equipped with 7inch high definition IPS touch screen for intuitive operation, very suitable for various performance venues, school, intelligent building, industrial and mining enterprise, individual use, etc.

Features

- 12 mic input, 2 Stereo input
- 1 S/PDIF I/O AES/EBU output
- 16 busses 4 Mono output busses, 5 Stereo output busses, 1 Stereo monitor bus
- 8 assignable XLR output connectors
- 1 Stereo monitor output connector & 1 headphone output connector
- one 7" 1024x600 touchscreen
- IPS touch screen with adjustable angle
- 8 internal effect modules
- 2 USB plugs provide stereo recording/playing/system update/cue files import and export cue memory
- iPad remote control

Control and connection

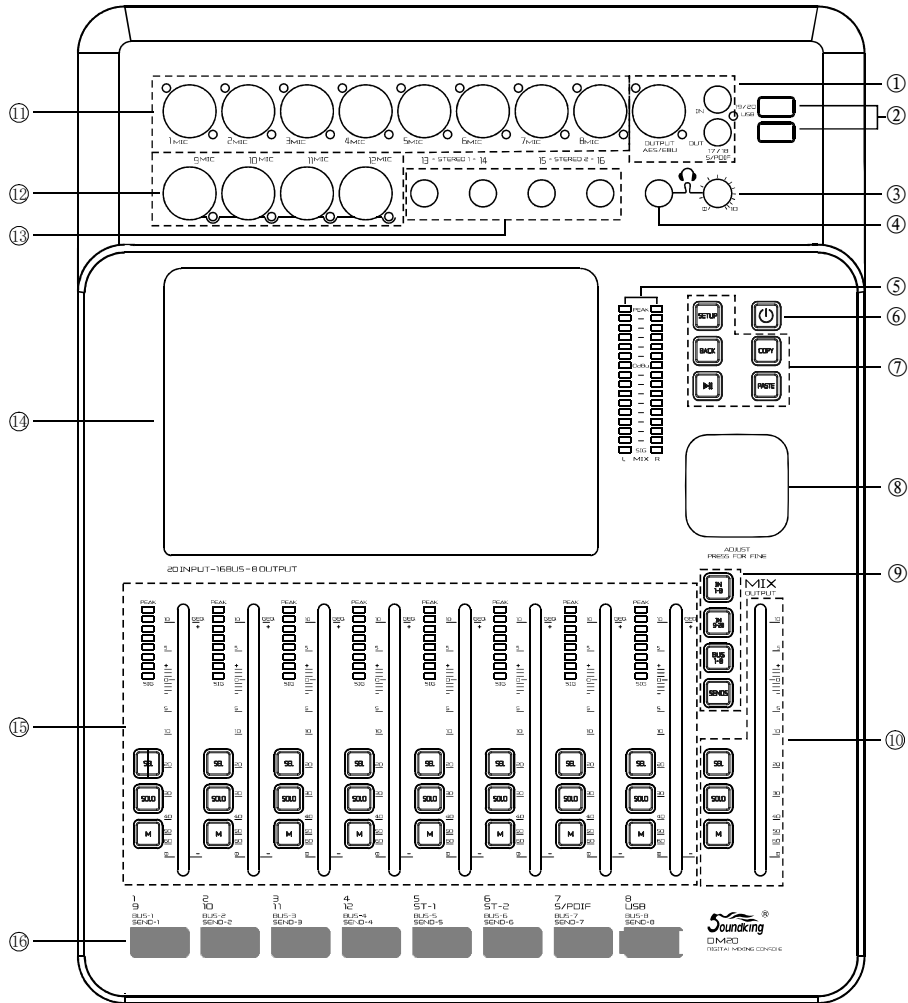

(DM20 Mixer panel)

- ① S/PDIF in/out connector AES/EBU output connector
- ② two USB 2.0 interface
- ③ headphone volume
- ④ headphone connector
- ⑤ master out 16 band level meter
- ⑥ POWER keep pressing 3 to turn on/off the unit. Press for 1S for lock function and all buttons can not work.

The screen turns black. Press again to exit the lock function.

5.3. Open the APP just downloaded.

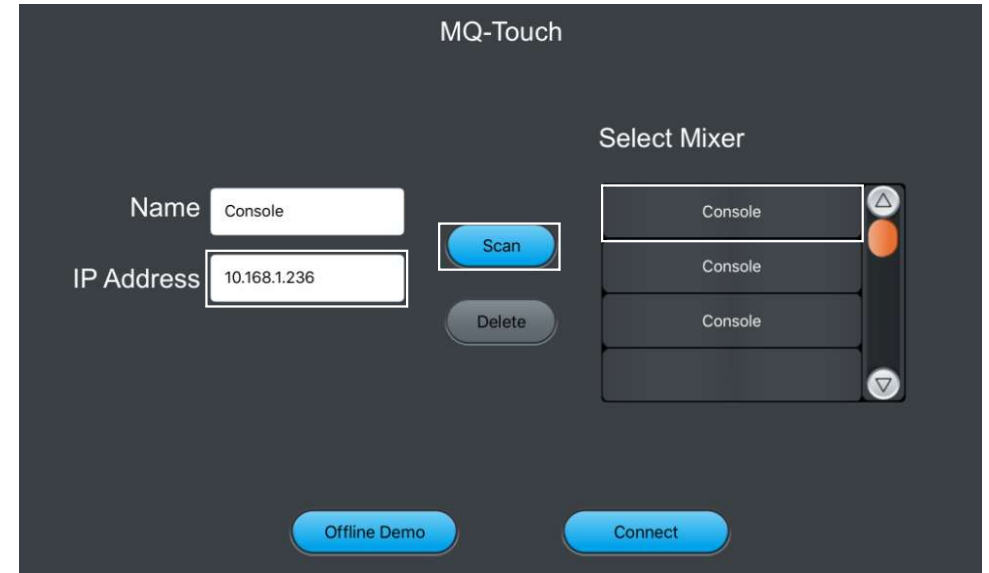

- 5.4. Click **Scan** shown above to search, find Console, click **Connect**. If many Consoles appear, type in the IP address of mixer you want for direct connection. If necessary, you can change name in **Name Console** to differentiate your devices. Note: you can check IP address in "Setup" of mixer.

5.5. Initial interface for IPAD log-in is shown as below.



IPAD Part

5.1. Use the IPAD from Apple Inc, search “soundking” or “DM20” in App Store, as shown below, install the APP accordingly.

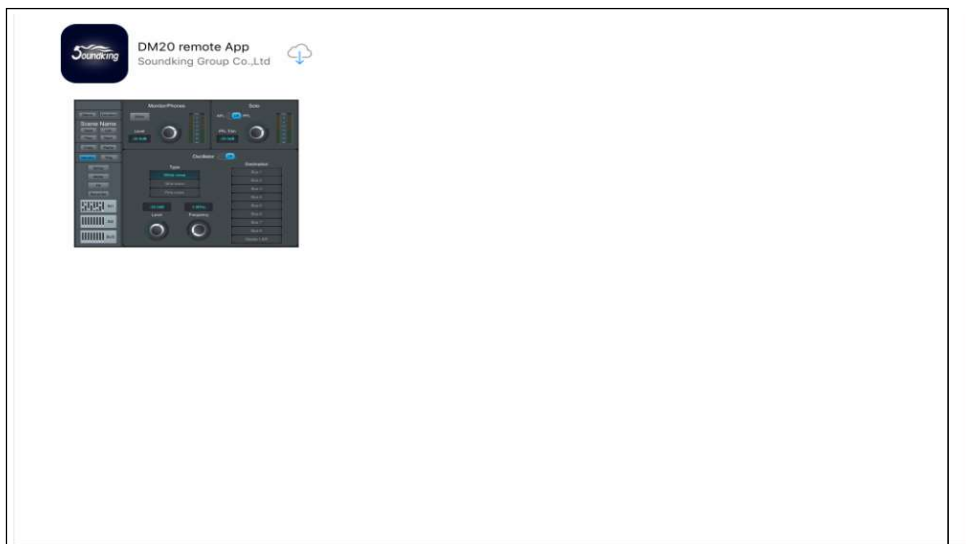

5.2. Click “Settings”-“WLAN” in IPAD, select the same WIFI or the AP, as shown below.

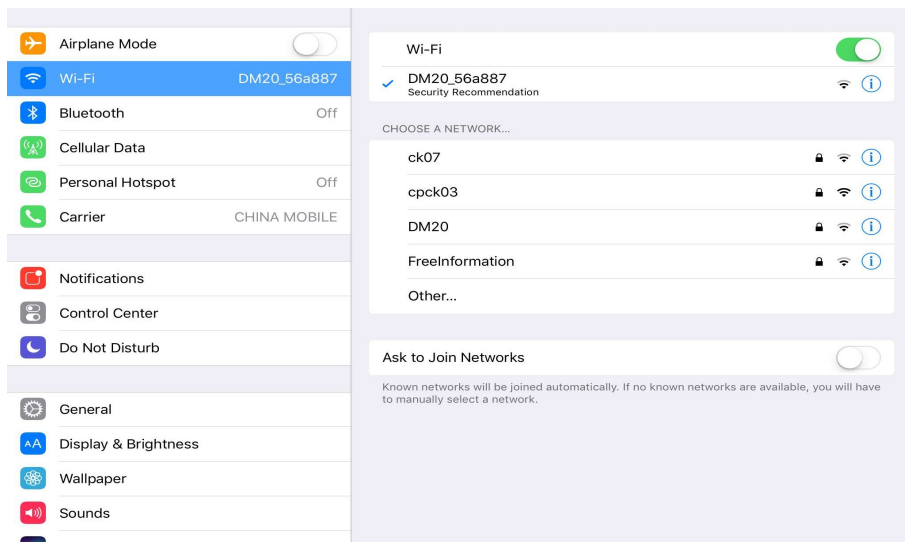

- ⑦ five buttons SETUP BIACK PLAY/PAUSE, COPY, PASTE.
SETUP is enter the system page.
BIACK is to exit the system.
COPY and PASTE is to copy and paste the channel parameter setting.
PLAY/PAUSE play/pause the audio source in USB.

- ⑧ parameter adjustment
- ⑨ flip page: INPUT1-8 INPUT9-12 ST-USB and BUS1-8
SEND is the fader send mode button. When the system in In1 or In2 page press SEL to select one channel, Press SENDS. You can use physical fader to control the BUS send level (Bus 1~Bus 8 LR). After entering SENDS MUTE switch is the switch to turn on/off Send BUS function. SOLO is to send quickly set 0 function.

- ⑩ The channel strip with SELECT, SOLO, MUTE/ON and motorized fader
- ⑪ 8 channel XLR mic in connector
- ⑫ 4 channel Combo in connector
- ⑬ 2 Jack stereo in
- ⑭ 7 inch touch screen
- ⑮ SELECT button, SOLO button, MUTE/ON button, 8 band level meter and 100mm motorized faders
- ⑯ Channel labels

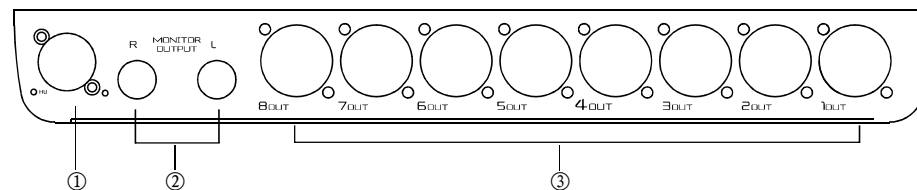

(DM20 Mixer rear panel)

- ① 12V power socket
- ② Stereo monitor output connector
- ③ 8CH bal output connector

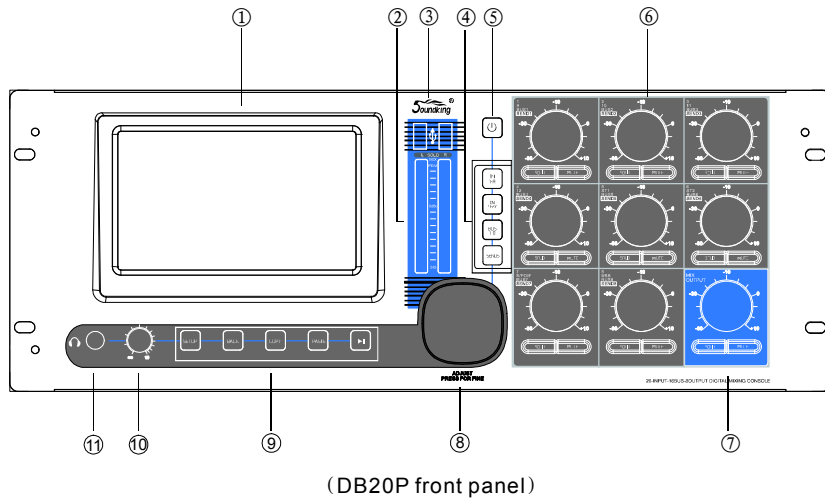

(DB20P front panel)

- ① 7" high definition touch screen
- ② Main output, 16-band level meter
- ③ USB 2.0 interface
- ④ Three page turn buttons - INPUT1-8, INPUT9-12 ST-USB and BUS1-8
SEND - fader send mode button, when system rests on IN1 or IN2 and one certain channel is selected by pressing SEL, Press SENDS, physical fader can adjust the bus send level of this channel (Bus1-Bus8, LR),
After enter SENDS, MUTE button can open the Bus Send function, SOLO can fast set zero for Send channel
- ⑤ POWER button: long press 3 sec to power on/off; short press 1 sec to Lock when all physical buttons are invalid and the screen blacks out; short press again to exit Lock
- ⑥ Button features SELECT, SOLO, MUTE/ON, 8-band level meter and CH control
- ⑦ Button features SELECT, SOLO, MUTE/ON and main output CH control
- ⑧ Parametric button
- ⑨ Five buttons from left to right: SETUP, BLACK, COPY, PASTE, PLAY
Press SETUP to enter system page
Press BLACK to exit
Press COPY/PASTE to copy/paste the parametric setting of channel
- ⑩ Headphone volume
- ⑪ Headphone jack

3. WIFI Mode Log-in, Mixer Setting

Suitable for all fixed places covered with WIFI, remote distance depends on the power of your wireless router.



- 3.1 Click **Wi-Fi OFF** tab shown above, select the correct WIFI you need in the list.
- 3.2 Click **Connect**, then type in your password for the wireless router.

AP Mode Log-in, Mixer Setting

For places not covered with WIFI, you can log in by AP mode.



- 4.1 Click **AP | Hotspot ON** tag shown above, SSID will show you the default AP name of mixer.
- 4.2 You can change the name of SSID and decide if password is needed when log-in, then click "Save".

WIFI PAGE

Setting Mode One of IPAD WIFI Connecting Mixer

Firstly, please make sure you have plugged the WIFI module attached into the USB port of mixer.

Mixer Setting



1. Click "Setup" on the panel of mixer, enter SETUP tab page.

2. Click **SetupWifi** on the screen to enter WIFI setting page.

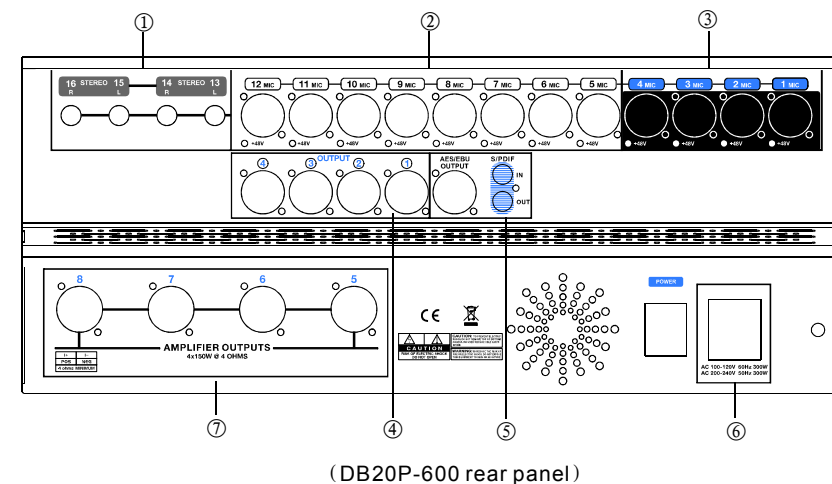
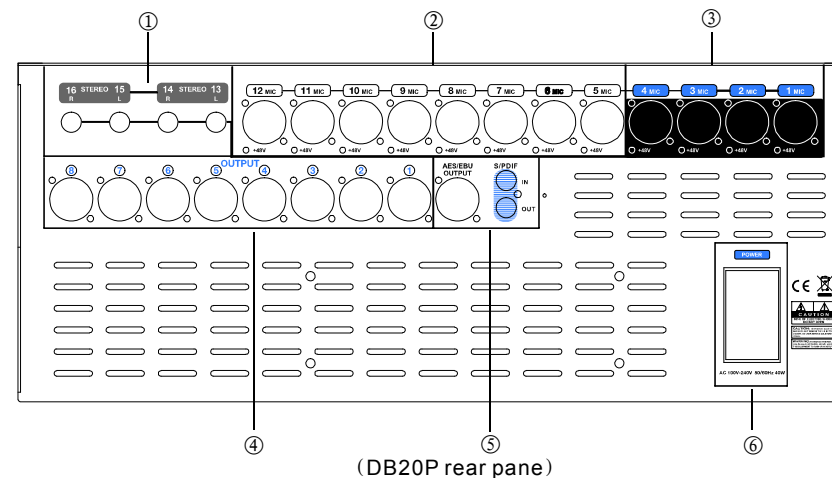
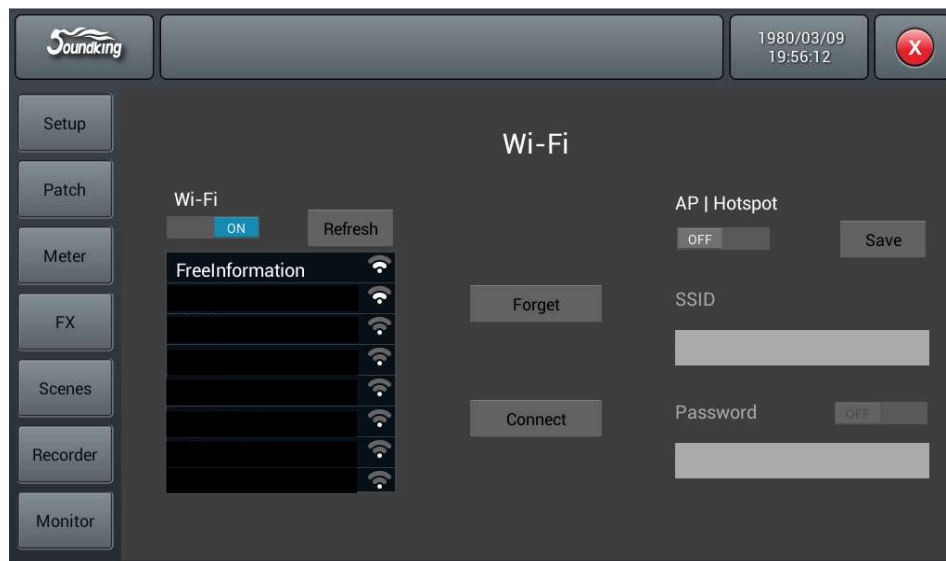

- ① 2 Stereo input
- ② 8 XLR MIC input
- ③ 4 Combo input
- ④ Balanced output, XLR 7/8 is preset as main L/R output
- ⑤ S/PDIF in/out
- ⑥ AC input
- ⑦ Internal AMP output

Input Channel

DM20 has 12-channel mono inputs, 2 analogue stereo inputs, 1 stereo S/PDIF input channel and 1 stereo USB input. INPUT 1-8 and INPUT 9-12 ST-USB buttons are for input page up/page down. INPUT 1-8 covers 8 channels MONO input channel CH1~CH8, INPUT 9-12 ST-USB covers 4 mono inputs (CH9~CH12), 2 analogue stereo input channels, 1 stereo S/PDIF input and 1 stereo USB input. Press NPUT1-8 and INPUT9-12 ST-USB page button, or slide left/right to flip pages.

MIC Channel

MIC input channels possess five individual modules, which are Input Stage, EQ, Dynamics, Bus Send and Output Stage. With single press any module, the sub-page will pop up and you could shut it down if you press the "close" button.



① Input Stage

This module indicates settings of 48V phantom power, phase, delay, HPF and effects insert on the channel

② EQ

This module indicates EQ curves on the channel

③ Dynamics

This module indicates Dynamics curves on the channel

④ Bus Send

This module indicates status of sending inputs to Busses, including the bus being sent and its level and Pan value.

⑤ Output Stage

This module displays Mic input channel's name, Pan value, Solo, Mute, fader level setting and level meter information. Single press **CH1**, channel name and color can be edited, and you could specify the channel name and color with the soft keyboard popped up at the same time.

Monitor Page

The page mainly contains settings for Oscillator, Monitor / Phones and Solo.



① Oscillator

Oscillator of the console used for system test and calibration.

On/Off Switch: Single press the button to switch on (ON) Oscillator, press again to switch off. The default is disabled.

Type: there are three types of signals generated by Oscillator White noise/ Sine wave/ Pink noise, Single press an option in the list to select a Oscillator type.

Level: ranges from -8 dB to 0 dB, with a default @ 30 dB. Adjust the Level by turning the main Encoder or on the touch screen (fine tuning can be activated by pressing the main Encoder knob). Double press the parameter frame to set it as default.

Frequency: Frequency settings for ? Sine wave? , ranges from 10 Hz to 20 kHz, with a default @ 1 KHz. Adjust the parameter value by turning the main Encoder or on the touch screen (fine tuning can be activated by pressing the main Encoder knob). Double press the parameter frame to set it as default.

Destination: double press the bus in the list to enable the bus to which Oscillator signal transmits

② Monitor/Phones

On the upper right there is a Phone jack connector, and an analogue potentiometer knob for controlling the volume of earphone. A pair of three-core jack output connector for stereo monitor on the back panel, is used to connect monitor speakers.

Level: ranges from -8 dB to 0 dB, with a default @ -20 dB. Adjust the Level value by turning the main Encoder or on the touch screen (fine tuning can be activated by pressing the main Encoder knob). Double press the parameter frame to set it as default.

Mute: Single press the button to lighten the red LED button and mute monitor signal, press again to disable mute. The default is disabled. Note: The phone signal and monitor signal are the same, which is subject to control of monitor level and mute, except analogue gain.

Meter Display: Display Monitor level of output signal in real time.

③ Solo

If none of SOLO buttons is pressed down on the panel, therefore monitor is fed with master output. When press down any of SOLO button, then the channel feeds monitor with AFL or PFL signals. Press once to enable SOLO, press again to disable it.

PFL monitors pre-fader signal which is not subject to control of faders and mutes. If PFL is chosen for stereo channels, then it feeds monitor with a mixed signal from left and right channels. AFL signal monitors post-fader signal which is subject to control of faders and mutes.

AFL/PFL Select button: Choose a mode of monitor, while default is AFL mode. Single press the button and switch to PFL mode, press again to resume AFL mode.

Trim: Gain tuning of AFL or PFL, ranges from -8 dB to 0 dB, with a default @ -20 dB. Adjust the Trim by turning the main Encoder or on the touch screen (fine tuning can be activated by pressing the main value Encoder knob). Double press the parameter frame to set it as default.

Meter Display: Display the level of Solo signal in real time.

Recorder Page



① Player

The player can display the name of selected soundtracks and playback progress, includes 8 function buttons: stop (■) play/pause (▶/⏸) previous (◀) rewind (◀◀) forward (▶▶) next (▶) play mode (◻ ◻ ◻ ◻) and record (●).

② Meter display of playback and record

Display meter of Playback and Record in real time

③ Playback list

Display playlist in the USB disk, single press a soundtrack to play it.

④ Record

Record switch is OFF as default, and the sound source to be recorded is from Master L/R, single press the record button to record audio content of Master L/R bus to the USB disk in .WAV format.

Input Stage subpage



① 48V phantom power

Press the key, to enable the 48V phantom power. Press again to disable it. The default is set as disabled.

② Switch channels

Press the key, to choose previous or next channel within a same layer

③ REV

Press the key to enable reverse. Press again to disable it. The default is set as disabled.

④ Delay

Press to enable the delay, and the default is set as disabled. To adjust the time of delay by turning the main Encoder on the control panel or on the touch screen (fine tuning can be activated when pressed the knob down). The delay ranges from 0ms to 200ms, while the default is 0ms.

⑤ HPF

Press to enable the HPF, and the default is set as disabled. To adjust the frequency of HPF by turning the main Encoder on the control panel or on the touch screen (fine tuning can be activated when pressed the knob down). The frequency ranges from 16 Hz to 400 Hz, while the default is 16 Hz.

⑥ Insert

Press the key of any effect module, to insert this module before the EQ on the channel. All effects cannot be used on more than one channel, and all inputs can only be inserted with one effect module (the link parameter of this module is the serial number of the channel). The busses (Bus1~Bus8, L&R) can be inserted with two effect modules at the same time, which is sequenced to insert into the bus by the priority of selection. When the selected module is occupied by other channel or bus, you will see a window popped up and say: "The module can be used only once and it is already used by **. Are you sure you want to use the module forcibly now? Yes No". Access path of effect setting: SETUP→FX→double press to select the module

EQ Sub Page

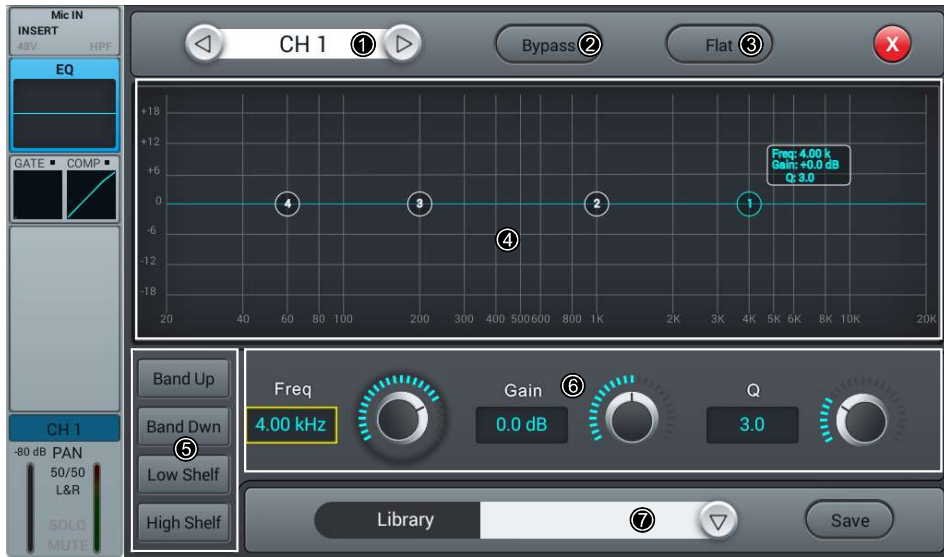

① Switch Channels

Single press the key to switch between previous or next channel on the same layer

② Bypass

Single press the key to enable Bypass, i.e. bypassed the EQ, press again to bring the EQ back. The default is set as disabled.

③ Flat

Single press the key to flat the curves in EQ graph. The default is set as disabled.

④ 4-band EQ graph

There are four points on the curve stand for the key frequencies (each ranges from 20Hz to 20KHz) of four bands EQ filters, which you could drag, in order to set parameters of 4-band EQ filters. There is a floating frame shows the parameter (gain, key frequency and Q value) of this filter when you selected a certain point on the curve.

⑤ Select Key of 4-band EQ filter

Single press the key of a certain frequency range, to select the filter for it.

⑥ Parameter Settings

To adjust Gain, Frequency or Q value with the touch knob or the knob on the control panel (general tuning by normally turning the main Encoder, press down the knob to access to the fine tuning)

Gain: to allow 18dB reduction or increase within the selected frequency range, default as 0dB.

Frequency: Band up/Band Dwn can switch between 4 frequencies; Low shelf/High Shelf can switch 1 and 4 to Shelf mode.

Q: adjust the bandwidth of 4-band filters in the EQ, ranges from 0.5(wide) to 10.0(narrow), default as 0.5.

Scenes Page

The page contains Scene List and operations for scenes.



① Scene List

Scene List contains number(No) selection(Sel) name(Name) and creat/update time(Time). To select a certain scene through single pressing option frame in the Sel column.

② Operation

Delete Delete scenes. When select a scene, single press the button, a dialog pops up "Are you sure you want to delete this scene?" single press "Yes" to delete the scene, single press "No" to cancel delete.

Rename Rename scene. When select a scene, single press the button, then you could edit the name the scene through a soft-keyboard popping up. Press confirm once you have renamed the scene.

Copy Copy scene. When select a scene, single press the button, to insert copied new scene after selected scene, the system will automatically name it as "(copied scene name)_copy".

New Create scene. Single press the button, to insert new scene after selected scene or current scene, system will name it as "New * " (* being a number, equals to the number of scene+1).

Save Save scene. Single press the button, to save console's settings to the current scene.

Load: Load scene. When select a scene, single press the button to load the scene.

Import load a scene from a USB disk. Single press the button, a dialog pops up "Compressed file list", select scene* list beneath "Compressed file list", to load scene from USB disk to the scene list on the console. If load successfully, system prompts "Import success", press "Confirm" and selected scene will be transported to the console from the U disk. If USB disk cannot be found, then prompts "No USB stick detected, please reconnect and try again." If cannot find scene file in the USB disk, then prompts "Scenes file not found on USB stick!". If loaded scene shares a same name with the scene file in the console, the system will automatically rename it as "(original file name)_USB".

Export Export scene file from console to USB disk. Single press "Sel" option frame in the scene list, to select scene to be exported. They can be exported individually or multiply. Then single press "Export" button. If export successfully, system prompts "Export success", press "Confirm" to export selected scenes to USB disk. If USB disk cannot be found, then prompts "No USB stick detected, please reconnect and try again."

Up move scene upward. When select a scene, single press the button to move selected scene upward, one press for one row.

Down move scene downward. When select a scene, single press the button to move selected scene downward, one press for one row. This function can be used to serve sorting purpose in both ascending order and descending order.

Prev browse previous scene. Single press "Load" to load the current scene once you have seen the scene you want

Next browse next scene. Single press "Load" to load the current scene once you have seen the scene you want

Now click measure, and there will be a dialogue indicating that the device will start measuring for 60 seconds. Please don't touch any of the faders or knobs during the measurement process as this may significantly influence the result.



When the measurement is finished the Measure button will turn off. Now close the GEQ dialog and insert the GEQ in the LR bus either in the effects page or the input section of the LR bus. Then return to the GEQ, turn down the master fader and click apply, which will change your faders to equalize according to the last measurement.



Please note that frequencies below 40Hz and above 16kHz are not automatically corrected, so you have to tune them manually.

Library

Save or load user's EQ settings. Single press the dropdown button and select a library file from a popped-up list, in order to load the EQ setting. Single press the ?Save? button after you have done with EQ settings, then select the library file (there are 16 names of library, Preset 1~Preset16) from the popped-up list. You could simply edit the name of library with a popped-up keyboard and press ?confirm? or ?cancel? to save it or not.

Dynamics sub-page

The sub-page includes channel selection, library, Gate, Compressor, Side Chain, etc.



1 Switch Channels

Single press the key to switch between previous or next channel on the same layer

2 Side chain

press dropdown button, and select Side chain channel (CH1~CH12) in the list (CH1~CH12 ST1 ST2). Side Chain can select Pre/Post Eq of other single channel.

3 Gate

IN: Single press the key to enable Gate, press again to disable it. The default is set as disabled.

Gate curve: Y-axis indicates the Threshold, X-axis indicates time factor. Up curve is determined by Attack, horizontal curve is determined by Hold, down curve is determined by Release.

Parameter Adjustment: To adjust the parameter of Gate by dragging the slider, or turning the main Encoder on the control panel (fine tuning can be activated when pressed the knob down). Double press the parameter frame to set it as default.

Threshold: Adjust the threshold of noise gate on the channel, ranges from -80 dB to 0 dB with default @ -80dB. Any signal lower than Threshold will be cut off, as a result, the level of the signal has to surpass the threshold in order to get through the noise gate.

Hold (time of hold): from 2 ms up to 2000 ms with default @ 2 ms.

Attack (time of start): from 0.5 ms to 100 ms with default @ 3 ms.

Release (time of release): from 2 ms to 2 s with default @350 ms (compatible with many kinds of sound source)

Depth: adjust attenuation of signals lower than the Threshold, ranges from 0 dB to -80 dB with default @-80 dB

④ Compressor

IN: Press the key to enable Compressor, press again to disable it. The default is set as disabled

Compressor: Threshold modifies breakpoint's position on the curve, Ratio modifies the bending rate of the curve above the breakpoint, Gain controls the vertical position of the diagonal.

Parameter Adjustment: To adjust the parameter of Gate by dragging the slider, or turning the main Encoder on the control panel (fine tuning can be activated when pressed the knob down).

Threshold: Adjust the Threshold of the compressor on the channel ranges from -80 dB to 0 dB with default @ -20 dB. Any signal lower than Threshold will not be compressed. To decrease the level of the signal higher than Threshold to a certain extent.

Ratio: Adjust compression ratio, from 1.0 to 20.0 with default @1.0.

Attack: from 0.5 ms to 100 ms with default @25 ms.

Release: from 20 ms to 5 s with default @350 ms (compatible with many kinds of sound source)

Gain: To compensate the compression, from -12 dB to +12 dB with default @0 dB.

⑤ Library

save or load the user Dynamics setting. Single press the button to display the library list to select one document. It loads the Dynamics setting. After setting the Dynamics parameters, single press Save button to display library list (16 library names, Preset 1~Preset 16 and select one document. This document is in the status of being edited. Change the library name via the displayed keyboard, then click Confirm to confirm the saving. If you do not want to change the library name, click Cancel.

⑥ Bypass

Single press the key to enable Bypass, to bypass Dynamics (Gate & Compressor), press again to disable Bypass meanwhile enable Dynamics. The default is set as disabled.

Set up your microphone at least several meters away from the speakers to pick up their full range. Ideally put it in the center position of the audience. Turn up the master fader sending pink noise to your system until your microphone clearly picks up the audio on the level meter of your microphone channel.

Please make sure there is no EQ or any other effects in neither the microphone channel and bus used for measurement, nor the LR output at this time.

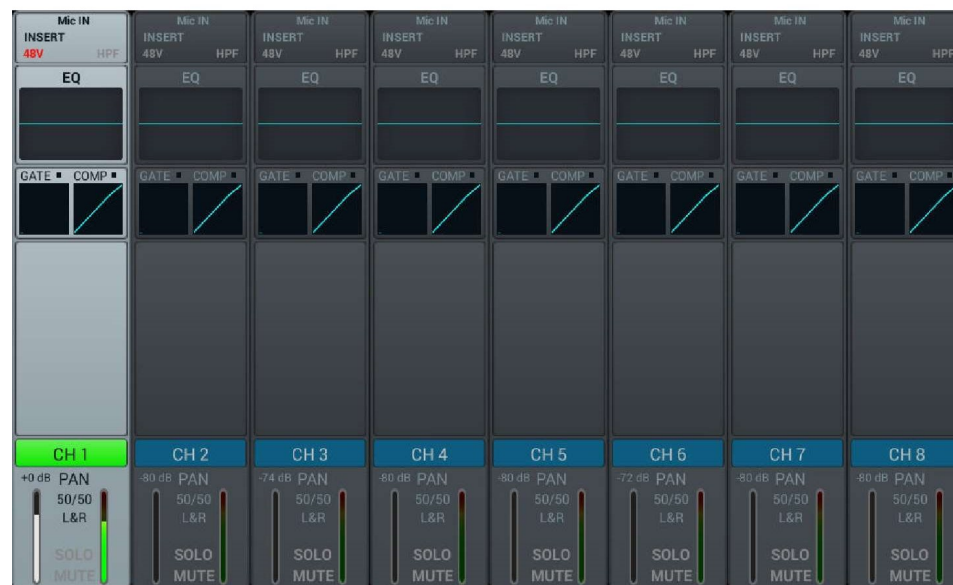

Enter the effects section in the Setup dialog and choose either GEQ1 or GEQ2 and turn on the RTA. Note that there are two modes normal (below) and difference that will more clearly show small changes. Which mode you use does not matter here.

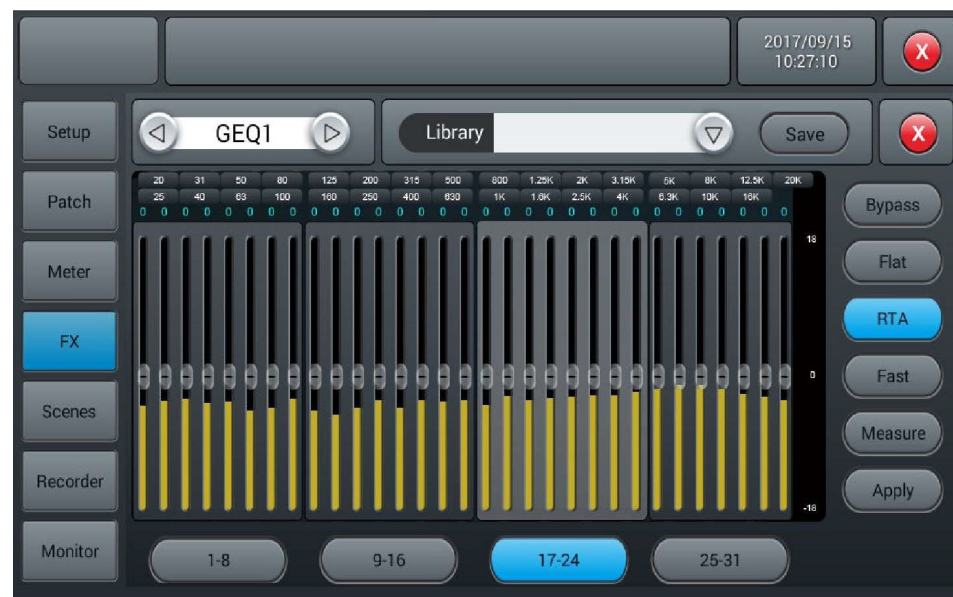

Go to the Patch page in the setup dialog. Choose one of the Custom settings and change the routing of USB L and USB R to your chosen stereo bus.



Now everything you microphone detects can be seen in the RTA on the GEQ page.

If you choose to use an external pink noise source the next part can be skipped. Otherwise please turn on the oscillator found in the Monitor section and set it to send to L/R MIX OUTPUT. Use either pink noise or sine sweep mode, here pink noise was used. Take care when using sine sweep though, as it is more susceptible to room resonances and may not lead to useful results in small or resonant rooms.



Set up your microphone at least several meters away from the speakers to pick up their full range. Ideally put it in the center position of the audience. Turn up the master fader sending pink noise to your system until your microphone clearly picks up the audio on the level meter of your microphone channel.

You may store the measurement like any other library for later use, but note that the response of a room can significantly change with the audience and also the setup of the PA system. Thus you will usually want to do a measurement with the exact PA and speaker setup as during the show.

Bus Send Sub-page

The input channel can send signal into 4-channel mono bus, 4-channel stereo bus and L/R master output bus.



① Channel Switch

Single press the key to switch between previous or next channel on the same layer

② Bus-send enable

Single press a bus button, to send signal to this bus, press again to disable the send.

③ PreFader/PostFader Switch

The default is set as PreFader, single press the key to switch to PostFader, press again to set it back to default.

④ PAN control

The default is set as 50|50, the PAN value can be tuned by dragging the slider, or turning the main Encoder on the control pane. Double press the parameter frame to set it back to default.

⑤ Send level control

Control the level of signal by drag the slider up and down.

Output Stage Sub-page

The sub-page mainly contains PAN, Solo, Mute, fader control and signal level display



① Switch Channel

Single press the key to switch between previous or next channel on the same layer

② PAN control

The default is set as 50|50, the PAN value can be tuned by touch knob, or physical knob on the control panel.

Double press the parameter frame to set it back to default.

③ Solo

Single press the key to enable monitor, press again to disable it. The default is set as disabled.

④ Mute

Single press the key to enable mute, press again to disable it. The default is set as disabled

⑤ Fader control

Control the volume of fader level by dragging the slider, or faders on the control panel, the parameter frame real-timely displays the value of PAN level. Double press the parameter frame to fast set it back to 0.

⑥ Meter level display

The level meter of channel signal, indicating post-fader signal level of the channel.

⑥ RTA Usage

With the RTA measure function your device can detect the frequency response of the room and try to correct it automatically.

You can either use the internal oscillator of the device, or an external pink noise source. You also need a high-quality measurement microphone; this should be connected to one of the 12 MIC input channels. Measurement microphones generally need phantom power, so make sure to turn on the 48V in the input section of your selected channel (here CH1) and turn up the gain until you get a proper signal.



Now go to the sends section and send your channel to one of the 4 stereo buses Bus5 to Bus8. Also turn off the send to LR.



GEQ Subpage

Double press “GEQ 1 or 2” in the FX Subpage, access to Subpage of GEQ parameter tuning, as showed in the picture below



① Module Selection

Single press left right selection button, to choose FX module: Modul1-Modul2-Delay1-Delay2-Reverb 1-Reverb2-GEQ1-GEQ2

② Library

Save or load user's EQ settings. Single press the dropdown button and select a library file from a popped-up list, in order to load the EQ setting. Single press the “ Save ” button after you have done with EQ settings, then select the library file (there are 16 names of library, Preset 1~Preset16) which can be edited through the soft-keyboard popping up. At last, press “ confirm ” or “ cancel ” to save file name or not.

③ GEQ Chart

The right side shows the Gain coordinate(+18 0 -18 dB), The up side shows the Frequency coordinate And gain value (default@0dB) of corresponding frequency point.Drag the slider up and down to adjust gain of frequency point, or use corresponding physical faders to do it.

④ Operation

Bypass: Single press the button, to enable Bypass. Press again to disable it. The default is disabled.

Flat: Single press the button, to set all gains of frequency points back to 0, bring slider in the middle (faders will be in the middle position of stroke if they are used to control), The default is disabled.

⑤ Fader selection button1-8

Single press the button, to control the gains of frequency points with 8 faders on the panel.

9-15 Single press the button, to control the gains of frequency points with 7 faders on the panel.

1-8 / 9-16 / 17-24 / 25-31: Single press 4 keys to switch between frequency points, use the 8 faders on the panel to adjust the gain of frequency point.

Stereo Channel

Stereo input and Mono channel are the same, also include five modules, which are Input Stage, EQ, Dynamics, Bus Send and Output Stage. Single press a module and a sub-page will pop up. Single press the close button on the subpage to exit.



Input Stage subpage



① Channel Switch

Single press the button to switch between previous or next channel on the same layer

② SUM

When only one connector (Left or right) of stereo is plugged, single press the button to copy the signal from one channel to another, then to the stereo processing channel. Press again to disable SUM. The default is disabled.

③ REV

Press the button to toggle phase inversion. The default is set as normal phase.

④ Trim

Single press the button to enable Trim, The default is disabled. Adjust the Trim by turning the main Encoder or on the touch screen (fine tuning can be activated by pressing the main Encoder knob). Trim ranges from -20 dB to 20 dB, and the default is 0 dB.

⑤ HPF

Press the button to enable the HPF; the default is disabled. Adjust the frequency of HPF by turning the main Encoder or on the touch screen (fine tuning can be activated by pressing the main Encoder knob). The frequency ranges from 16 Hz to 400 Hz, while the default is 16 Hz.

⑥ Insert

Press the button of any effect module to insert this module before the EQ on the channel. Each effect can only be used on one channel, and each channel can only be inserted with one effect module (the link parameter of this module is the serial number of the channel). The busses (Bus1~Bus8, L&R) can be inserted with two effect modules at the same time, which is sequenced to insert into the bus by the priority of selection.

When the selected module is occupied by other channel or bus, you will see a window popped up and say: "The module can be used only once and it is already used by **. Are you sure you want to use the module forcibly now ? Yes or No".

EQ subpage

The subpage is the same as the EQ subpage of MIC channels, please refer to the mic channel EQ subpage

Dynamics subpage

The subpage is the same as the Dynamics subpage of MIC channels, please refer to the mic channel of Dynamics page.

① Module Selection

Single press left right selection button, to choose FX module: Modul1-Modul2-Delay1-Delay2-Reverb 1-Reverb2-GEQ1-GEQ2)

② Type

Single press dropdown button, then choose a wanted type from the dropdown list
Hall Bright/Hall Warm/ Room Bright/ Room Warm /Plate Bright/ Plate Warm

③ Dry-Wet

Ranges from 0 to 100 with a default @ 0. Adjust the parameter of Dry-Wet by dragging the slider, or turning the main Encoder on the control panel.

④ EQ LS

Curve chart: displays the LS curve

Gain ranges is ±18 dB, with a default @ 0 dB. Adjust the Gain by turning the main Encoder or on the touch screen (fine tuning can be activated by pressing the main Encoder knob). Double press the parameter frame to set it as default.

Freq ranges from 20 Hz to 200 Hz, with a default @ 100 Hz. Adjust the Frequency by turning the main Encoder or on the touch screen (fine tuning can be activated by pressing the main Encoder knob).

Double press the parameter frame to set it as default.

⑤ EQ HS

Curve chart: displays the HS curve

Gain ranges is ±18 dB, with a default @ 0 dB. Adjust the Gain by turning the main Encoder or on the touch screen (fine tuning can be activated by pressing the main Encoder knob). Double press the parameter frame to set it as default.

Freq ranges from 1.5 KHz to 15 KHz, with a default @ 6.3 KHz. Adjust the Frequency by turning the main Encoder or on the touch screen (fine tuning can be activated by pressing the main Encoder knob). Double press the parameter frame to set it as default.

⑥ Other parameter

Time: the parameter can set the basic size of simulated room, ranges from 0 to 15 s, with a default@8 s. To adjust by turning the main Encoder or on the touch screen (fine tuning can be activated by pressing the main Encoder knob). Double press the parameter frame to set it as default. Chart 2 is time parameter range and default setting of different types.

Chart 2

Type	Min	Max	Default
Hall Bright	0.8 s	12.0 s	1.6 s
Hall Warm			
Room Bright	0.4 s	8.0 s	0.8 s
Room Warm			
Plate Bright	0.4 s	6.0 s	0.6 s
Plate Warm			

Pre Delay: configure time of Pre Delay, ranges from 0~100ms, with a default @ 0ms. To adjust by turning the main Encoder or on the touch screen (fine tuning can be activated by pressing the main Encoder knob). Double press the parameter frame to set it as default.

Chart 1

Factor	Ratio to BPM
1	1/24
2	1/16
3	1/12
4	1/8
5	1/6
6	1/4
7	1/2
8	Equivalent to BPM
9	x 2
10	x 3
11	x 4
12	x 5
13	x 6

Feedback: to return output delay into input, so as to generate echo from amplitude attenuation. Ranges from 0 to 90, with a default @ 0. To adjust by turning the main Encoder or dragging slider on the touch screen (fine tuning can be activated by pressing the main Encoder knob).

ReverbSubpage

Double press “Reverb1 or 2” in the FX Subpage, access to Subpage of Reverb parameter tuning, as showed in the picture below



Bus Send Subpage

The Bus Send subpage of Stereo ST1 and ST2 is the same as Mono channel, please refer to P10. S/PDIF and USB Channel can only be sent to Bus5~ Bus8 and Master L&R, the operation is the same as the stereo send of Mono Channel, interface as below.



Output Stage Subpage

For this part, please refer to the Subpage of Output Stage of Mono Channel

Output busses

DM20 has 14 output busses 4 Mono (Bus1~Bus4) and 5 Stereo (Bus5~Bus8), Master L&R. By default, BUS1-8 page shows processing stripe for Bus 1~Bus 8. When the system stays at the page of BUS1-8, press down “SEL”, the selection button of L&F master output on the panel, to move BUS page two stripes left and shows the channel info of Bus 3~Master L&R. If you press the “SEL” of Bus 1or Bus 2, then the bus page will move right and shows the channel info of Bus 1~Bus 8.

The output busses processing channel consists of 4 modules--- Input Stage, EQ, Input Source and Output Stage, which all have subpages except Input Source. Single press a module and subpage will pop up, press the close button to exit.

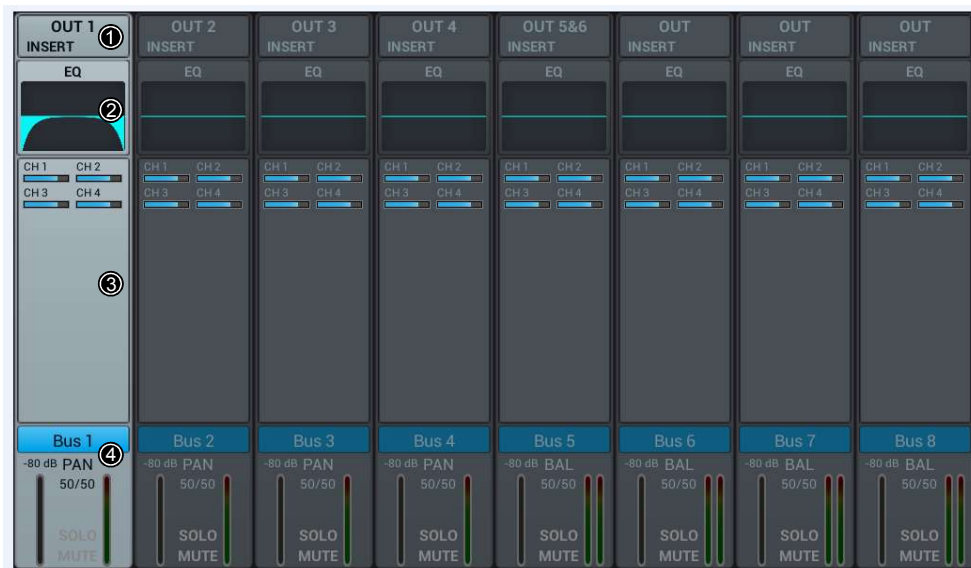

① Input Stage

The module shows the setup of output and effect insert which are assigned from the bus.

② EQ

The module shows the EQ curve of the bus.

③ Input Source

The module shows the channel info sent to the bus

④ Output Stage

The module shows the name of the bus, Pan/BAL value, Solo, Mute, delay setup, fader level and meter

By double pressing **Bus 1** the name of the channel can be edited through the soft-keyboard popping up.

Mono Bus Bus 1 ~Bus 4 are Mono busses.

Input Stage Subpage

The page contains Send and Insert. Bus1~Bus4 can send signal to Bus5~Bus8 and L/R master output, Bus5~Bus8 can only send signal to L/R master output.

OUT3 indicates physical output 3 assigned to the bus, and it shows OUT if there is no bus assigned to the physical output. Please refer to the page of Patch for operation of assigning busses to physical outputs.

① Module Selection

Single press left right selection button, to choose FX module: Modul1-Modul2-Delay1-Delay2-Reverb 1-Reverb2-GEQ1-GEQ2)

② Type

Single press dropdown button, then choose a wanted type from the dropdown list One Echo 1/4 Two Echo 1/8 Three Echo 1/16 Three Echo 1/16 Delayed Four Echo 1/16 One Echo 1/4 with 4 Reflect.

③ Dry-Wet

Ranges from 0 to 100 with a default @ 0. Adjust the parameter of Dry-Wet by dragging the slider, or turning the main Encoder on the control panel.

④ EQ LS

Curve chart: displays the LS curve

Gain ranges is ± 18 dB, with a default @ 0 dB. Adjust the Gain by turning the main Encoder or on the touch screen (fine tuning can be activated by pressing the main Encoder knob). Double press the parameter frame to set it as default.

Freq ranges from 20 Hz to 200 Hz, with a default @ 100 Hz. Adjust the Frequency by turning the main Encoder or on the touch screen (fine tuning can be activated by pressing the main Encoder knob).

Double press the parameter frame to set it as default.

⑤ EQ HS

Curve chart: displays the HS curve

Gain ranges is ± 18 dB, with a default @ 0 dB. Adjust the Gain by turning the main Encoder or on the touch screen (fine tuning can be activated by pressing the main Encoder knob). Double press the parameter frame to set it as default.

Freq ranges from 1.5 KHz to 15 KHz, with a default @ 6.3 KHz. Adjust the Frequency by turning the main Encoder or on the touch screen (fine tuning can be activated by pressing the main Encoder knob). Double press the parameter frame to set it as default.

⑥ Other parameters

Factor ranges from 0 to 13, with a default @ 1. Adjust the Factor by dragging the slider, or turning the main Encoder on the control panel. (fine tuning can be activated by pressing the main Encoder knob).

Tempo ranges from 40 to 240 BPM, with a default @ 80. Adjust the Tempo by turning the main Encoder (fine tuning can be activated by pressing the main Encoder knob).

Tap Tempo: Keep pressing this button to set BPM value, at least three times of pressing.

Delay Time: ranges from 0 to 2000 ms, with a default @ 750ms. Adjust the time parameter by turning the main Encoder or on the touch screen (fine tuning can be activated by pressing the main Encoder knob). Double press the parameter frame to set it as default.

Delay Time can be configured by Factor and Tempo (see Chart 1 for the relation). Factor corresponds to regular tuning, while Tempo corresponds to fine tuning. For example, set Factor to 8, Tempo to 120 BPM, Delay Time is $500 \text{ ms} \times 60 \times 1000 / 120 = 500$. if set Factor to 9, Delay Time will be 1000 ms. if Factor to 7, Delay Time will be 250 ms.

④ EQ LS

Curve chart: displays the LS curve

Gain: ranges is ± 18 dB, with a default @ 0 dB. Adjust the Gain by turning the main Encoder or on the touch screen (fine tuning can be activated by pressing the main Encoder knob). Double press the parameter frame to set it as default.

Freq ranges from 20 Hz to 200 Hz, with a default @ 100 Hz. Adjust the Frequency by turning the main Encoder or on the touch screen (fine tuning can be activated by pressing the main Encoder knob). Double press the parameter frame to set it as default.

⑤ EQ HS

Curve: displays the HS curve

Gain ranges is ± 18 dB, with a default @ 0 dB. Adjust the Gain by turning the main Encoder or on the touch screen (fine tuning can be activated by pressing the main Encoder knob). Double press the parameter frame to set it as default.

Freq ranges from 1.5 KHz to 15 KHz, with a default @ 6.3 KHz. Adjust the Frequency by turning the main Encoder or on the touch screen (fine tuning can be activated by pressing the main Encoder knob). Double press the parameter frame to set it as default.

⑥ Other parameters

Speed ranges from 50 to 200, with a default @ 100. Adjust the Speed by dragging the slider, or turning the main Encoder on the control panel (fine tuning can be activated by pressing the main Encoder knob).

Intensity ranges from 50 to 200, with a default @ 100. Adjust the Intensity by turning the main Encoder or on the touch screen (fine tuning can be activated by pressing the main Encoder knob).

Pre Delay configure time of Pre Delay, ranges from 0~100ms, with a default @ 0ms. Adjust the time parameter by turning the main Encoder or on the touch screen.



① Switch Channel

Single press the button to switch between previous or next channel on the same layer

② Bus send enable

Single press a bus button, to send channel signal to the bus, press again to disable.

③ PreFader/PostFader toggle selection

The default is PreFader. Single press the button, to toggle PostFader, press again to set it back to default.

④ PAN control

The default is 50|50, the PAN value can be tuned by dragging the slider, or turning the main Encoder on the control panel. Double press the parameter frame to set it back to default.

⑤ Send level control

Control the level of signal by drag the slider up and down.

⑥ Insert

Press the button of any effect module to insert this module before the EQ on the channel. All effect module cannot be shared on more than one channel. The busses (Bus1~Bus8, L&R) can be inserted with two effect modules at the same time, which is sequenced to insert into the bus by the priority of selection. When the selected module is occupied by other channel or bus, you will see a window popped up and say: "The module can be used only once and it is already used by **. Are you sure you want to use the module forcibly now? Yes or No "

EQ Subpage

This Subpage is the same as EQ Subpage of the MIC channel, please refer to MIC channel EQ page.

Output Stage Subpage

The page contains Delay, PAN, Solo, Mute, fader level control and signal level display. (the output of Bus5~Bus8 and L&R bus is similar with Bus1~Bus4).



① Switch Channel:

Single press the key to switch between previous or next bus channel on the same layer

② Delay:

Press **IN** to enable the delay; the default is disabled. Adjust the delay time by turning the main Encoder or on the touch screen (fine tuning can be activated by pressing the main Encoder knob). The delay ranges from 0ms to 200ms, while the default is 0ms.

③ PAN control:

The default is 50|50, the PAN value can be tuned by dragging the slider, or turning the main Encoder on the control panel. Double press the parameter frame to set it back to default.

④ Solo:

Single press the button to enable monitor, press again to disable it. The default is disabled

⑤ Mute:

Single press the button to enable mute, press again to disable it. The default is disabled

⑥ Fader control:

Control the volume of fader level by dragging the slider, or faders on the control panel, the parameter frame real-timely displays the value of fader level. Double press the parameter frame to fast set it back to 0.

⑦ Meter level display:

The level meter of channel signal, indicating post-fader signal level of the channel.

The Effects have 8 modules, which are 2 Modulation, 2 Delay, 2 Reverb and 2 15-band GEQ. All the modules can be inserted to input processing channel or bus processing channel, for one time only. Note, input processing channel can only be inserted with one effect module, while the bus can have two.

① Effect module

Double press the effect module, then a subpage of parameter setting of this module pops up. Single press the close button on the subpage to exit, and return to FX page.

② Bus selection

Single press the dropdown button , and select bus (Bus1~Bus8 Master LR) from a dropdown list.

If the chosen bus has selected a FX module in the input part of the channel, then the left frame displays Selected FX modules in order of selection from left to right. If nothing has been chosen, you could drag the FX module above to the empty frame (if the FX module was occupied by other channel or bus, a dialog pops up "The module can be used only once and it is already used by **. Are you sure you want to use the module forcibly now? Yes or No").

Modulation Subpage

Double press "Modulation1 or 2" button in the FX Subpage, access to Modulation parameter tuning Subpage as below showed in the picture



① Module Selection

Single press left right selection button, to choose FX module (Modul1-Modul2-Delay1-Delay2-Reverb1-Reverb2-GEQ1-GEQ2)

② Type

Single press dropdown button, then choose a wanted type from the dropdown list Chorus Slow/Chorus Fast/Flanger Slow/Flanger Fast/Celeste Slow/Celeste Fast/Rotor Slow/Rotor Fast.

③ Dry-Wet

Ranges from 0 to 100 with a default @ 0. Adjust the parameter of Dry-Wet by dragging the slider, or turning the main Encoder on the control panel.

Meter Page

The page contains two parts: signal level from input processing channel and outputs.



Signal level of input processing channel has three modes IN, Pre Fader and Post Fader with Pre Fader as the default. To select signal level mode to be displayed through single pressing the button. The signal level of output has two modes Pre Fader and Post Fader with Pre Fader as the default. To select signal level mode to be displayed through single pressing the button. On the right side of signal level of outputs you can see the bus names which are assigned to the port.

FX page



Setup page

The page contains Information, Sample Rate, Delay Unit, System, WiFi, Remote, Brightness and Time & Date.



- ① **Scenes**
Shows the name of scenes.
- ② **Information**
System Version shows the version of APK, DSP, Fader and other softwares on this console. IP Address shows the IP address of the console.
- ③ **Sample Rate**
The default setting is 48.0 KHz. When single press 44.1 KHz, a window pops up " The Sample Rate of 44.1 KHz is only used for Digital Outputs. ", then the 44.1 KHz light on, and the 48 KHz light off. The default is always 48.0 KHz after rebooting the system
- ④ **Delay Unit**
Single press any one among three " ms ", " ft " and " m " buttons, to choose the unit of delay time. The default is " ms ". After rebooting the system, the unit of delay time is always what you set before you had powered off the console last time.
- ⑤ **System**
Contains Maintenance and Home Screener two options, please refer to the page of Maintenance Subpage for details.
- ⑥ **Brightness,**
Adjust the brightness of the touch screen.
Six units to indicate the level of brightness, the default is three units. After rebooting the system, the unit of brightness is always what you set before you had powered off the console last time.
- ⑦ **Crossover setting**
Single press SUB8 **IN** , the crossover works. At this time, BUS8 works in bass mode, the frequency adjustment knob can change the crossover frequency. Filter slope is 24dB/oct. The crossover frequency adjustment range is 40Hz-300Hz. Single press Master L/R **IN** button, crossover works. At this time, Master L/R works in the full range low cut mode. the frequency adjustment knob can change the crossover Frequency. Filter slope is 24dB/oct. The crossover frequency adjustment range is 40Hz-300Hz. Using these two crossovers reasonably can form 2.1 channel reinforcement mode.

Maintenance page



① Update from USB

Single press “ Update from USB ” button, a dialog pops up “ After the update the System will reboot automatically. Are you sure you want to update the System?”, press “ Install ” and complete the installation following the tip information.

② Factory Reset

Single press “ Factory Reset ” button, a dialog pops up “ Do you want to do a Factory Reset ” This reset your Settings to factory defaults. The System will restart automatically after finishing , then press “ Factory Reset ” and the console will automatically reboot.

If the console appears lagged in operation after a long-time running, you can use this function to reset the console to factory settings. However please save all your important data by exporting to a USB disk before you had reset the console which will irrevocably erase all the internal data.

③ Toggle Dev Mode

Debugging mode, not recommended to non-professional users.

④ Android Home Screen

Debugging mode, not recommended to non-professional users.

⑤ Import Settings

Debugging mode, not recommended to non-professional users.

⑥ Export Settings

Debugging mode, not recommended to non-professional users.

⑦ Time Settings

System time setting function, single click “ Time Settings ” to set system time.

⑧ Save Log

Debugging mode, not recommended to non-professional users.

Patch page

This page is mainly for selecting busses to be assigned to 8 analogue outputs, S/PDIF output and USB output. The console has 4 mono bus (Bus 1~Bus 4), 4 stereo bus (Bus 5L~Bus 8R) and master output bus Master L, Master R.



① Default

In Default mode, Bus1- Bus 5R are assigned to OUT 1 ~ OUT 6, Master L and Master R are assigned to OUT 7-8, S/PDIF OUT and USB OUT

② Custom

Switch to custom mode after single pressing “ Custom1 2 3 ” buttons. Single press “  ” of any output, then select the bus to be assigned. Thus finish the route settings from the busses to ports.

Notice: Can only S/PDIF and USB output in pair select stereo bus or master output bus, meanwhile, 8 analogue outputs can select any one out of 14 busses.

After rebooting the system, the Patch setting is always what you set before you had powered off the console last time.